



**IBU**

# **ADVERTISING RULES** **2022-2026**

APPROVED AT EB 167, 04-06 JUNE 2023

## **TABLE OF CONTENT**

---

	<b>MAP LEGEND / EXPLANATION OF ABBREVIATIONS</b>	<b>3</b>
	<b>PREAMBLE</b>	<b>3</b>
<b>A.</b>	<b>PRINCIPLES</b>	<b>4</b>
<b>B.</b>	<b>FORMS OF ADVERTISING</b>	<b>6</b>
<b>C.</b>	<b>IMPLEMENTATION OF ADVERTISING</b>	<b>7</b>
<b>D.</b>	<b>OFFICIAL EVENT NAME, TITLE SPONSOR</b>	<b>9</b>
<b>E.</b>	<b>WEBSITES</b>	<b>10</b>
<b>F.</b>	<b>PRINT MATERIAL</b>	<b>10</b>
<b>G.</b>	<b>ADVERTISING SURFACES ON ATHLETES AND SERVICE PERSONNEL</b>	<b>16</b>
<b>H.</b>	<b>COMPETITION FACILITY AREA</b>	<b>16</b>
<b>I.</b>	<b>OTHER ADVERTISING PANELS</b>	<b>24</b>
<b>J.</b>	<b>AREAS FOR HOST VENUE VISIBILITY</b>	<b>25</b>
<b>K.</b>	<b>AREAS OF ACTIVITY OUTSIDE THE COMPETITION FACILITY</b>	<b>25</b>
<b>L.</b>	<b>TV SCREEN RELATED ADVERTISING</b>	<b>26</b>
<b>M.</b>	<b>LIMIT OF PROVISIONS/ACKNOWLEDGEMENT OF CURRENT PRACTICE</b>	<b>27</b>
<b>ANNEX 1</b>		
	<b>INTERPRETATION/CLARIFICATION OF CHAPTERS C AND D</b>	<b>28</b>

## MAP LEGEND / EXPLANATION OF ABBREVIATIONS

---

International Biathlon Union	▶ further stated as <b>IBU</b>
IBU Advertising Rules	▶ further stated as <b>Rules</b>
Local Organizing Committee	▶ further stated as <b>LOC</b>
National Federation	▶ further stated as <b>NF</b>
IBU TV and/or IBU Marketing Partner	▶ further stated as <b>IBU Contract Partners</b>
IBU World Championships Biathlon	▶ further stated as <b>WCH</b>
IBU World Cup Biathlon	▶ further stated as <b>WC</b>
IBU Open European Championships Biathlon	▶ further stated as <b>OECH</b>
IBU Cup Biathlon	▶ further stated as <b>IBU Cup</b>
IBU Youth & Junior World Championships Biathlon	▶ further stated as <b>YJWCH</b>
IBU Junior Open European Championships Biathlon	▶ further stated as <b>JOECH</b>
IBU Junior Cup Biathlon	▶ further stated as <b>Junior Cup</b>
IBU Summer Biathlon World Championships	▶ further stated as <b>SB WCH</b>
WCH, WC, OECH, IBU Cup, YJWCH, JOWCH, Junior Cup, SB WCH	▶ further stated as <b>IBU Events</b>
Any members (athletes, coaches, wax technicians etc. of NF national teams)	▶ further stated as <b>Athletes or Team Members</b>
Combined logo from event/series and LOC logo	▶ further stated as <b>Composite Logo</b>
Event/series logo (left part of composite logo only)	▶ further stated as <b>Event Logo</b>
Host broadcaster	▶ further stated as <b>HB</b>

## PREAMBLE

---

The IBU Advertising Rules (Rules) apply to all IBU Events as defined in the IBU Event and Competition Rules (ECR). The Rules are binding to all rights holders in connection with all Advertising measures (Advertising) at IBU Events. Further specific rules define the correct use of event logos, composite logos and official layouts and are stipulated in the respective regulations such as the relevant IBU Event and Competition Rules or applicable style and venue dressing guides. These guides are available on IBU's website **[www.biathlonworld.com](http://www.biathlonworld.com)**.

The application of the Rules is generally subordinated to the safe performance of the event. Advertising may not at any time disturb or disrupt sport-technical operations in the competition areas.



## **A. PRINCIPLES**

---

### **A.1 Legal Basis and Scope of Application**

The Rules apply to all and in connection with all IBU Events. IBU Events are all international biathlon events and series officially established by IBU. For authorized/affiliated events or IBU Summer Series Events individual agreements are possible.

In this respect the Rules especially have to be applied by:

- NFs and their Athletes (host and participants)
- LOCs
- IBU Contract Partners and their contractual partners/members
- Service providers and companies

The implementation of any Advertising and sponsorship in connection with the IBU Events under these Rules have to be approved by IBU in due advance to the respective events.

### **A.2 Temporal Scope of Application**

The Rules apply year-round and irrespective of official beginning and end of a season.

Specific regulations for printed documents, websites, logos/emoles, trademarks and official event names must be observed anytime in connection with the respective event.

All other rules apply from the first official training at the latest, until and including the awards ceremony following the final competition or including the closing ceremony, if applicable.

The Rules (including potential amendments in these Rules & Annexe/s) are valid until 30 April 2026 and will be replaced by new advertising rules with effect as of 1 May 2026.

### **A.3 Geographical Scope of Application / Venue**

The Rules apply worldwide throughout the Venues as determined by IBU. The respective Venue comprises e.g. the competition area, its visible vicinity as specified in the respective Venue by IBU, the air-space above, related competition and media facilities and official award ceremony sites outside the competition area and further specific areas to be determined by IBU.

### **A.4 Copyright**

The IBU is the owner of worldwide registered and protected trademarks (IBU Trademarks), such as:

- a. IBU
- b. IBU International Biathlon Union
- c. biathlonworld
- d. IBU Event Logos

The use of IBU Trademarks is solely permitted as stipulated in the Rules and/or in further specification by written agreement. Event names, Composite Logos and any other marketing operation related to IBU Trademarks have to be approved by IBU in advance.

## **A.5 IBU Contract Partners**

IBU has licensed its media and marketing rights for several events/event series to its partners:

- IBU TV Partner - currently European Broadcasting Union/EBU
- IBU Marketing Partner - currently Infront Austria GmbH

Detailed information about the respective rights situation at IBU Events are part/annex of the respective Event Hosting Declaration (EHD) of the respective event.

## **A.6 National Laws and prohibited forms of Advertising**

Advertising means any advertising activity or any activity which effects advertisement. All Advertising must comply with the laws and regulations of the country hosting the IBU Event.

Any political and/or religious and/or any defamatory, discriminatory, racist or sexist Advertising and/or publications in any form are prohibited.

Any form of Advertising by making specific references to participants of the events (e.g. athletes and officials) is prohibited.

Independent from national laws and regulations, Advertising is prohibited for:

- Spirits (more than 15 % Vol.)
- Drugs (including medication)
- Tobacco products
- War related games and/or violent games
- Gambling (e.g. Casinos and Online-Casinos)\*

Advertising for sports betting/lotteries on or with the Athletes 18 years of age or older/their equipment is permitted only for NF partners/sponsors as a part of a team sponsorship and not for individual athletes and may not be placed anywhere on a hat/headband and only in the following cases:

- ▶ of and for state-controlled companies providing sports betting and/or lotteries. State-controlled means that the state owns the majority of shares of the company and/or the state has the majority of votes in the supervisory board of the company.
- ▶ of and for companies a) licensed in the NF's own country, b) regulated by the NF's own national betting regulator, c) whose primary headquarters and business is conducted in the NF's own country and d) who observe best practices in prevention of sport manipulation, betting by minors and addictive betting behaviour, as confirmed by the BIU.
- ▶ of and for companies providing non - sports betting/lotteries only.

NFs choosing to allow sports betting brands on their athlete uniforms/equipment are required to have their betting company confirmed as compliant with these rules by the BIU and to pay an annual fee for monitoring of manipulation to the BIU. The EB will determine the fee annually commensurate with the level of monitoring required.

Any other Advertising (not on or with Athletes/their equipment) of commercial (sports) betting companies/lotteries shall be permitted, subject to the respective national laws.

\* In the case (sports) betting companies/lotteries additionally provide gambling, Advertising shall in principle be permitted, provided that there will be no concrete reference to such gambling activities in connection with their Advertising measures under these Rules, always subject to the respective national laws.

Advertising for nutrition supplements is prohibited, unless a WADA accredited laboratory has officially confirmed that the product does not contain any prohibited substance that is listed on the WADA prohibited list.

## **B. FORMS OF ADVERTISING**

---

### **B.1 Definition of “Sponsor Logo” and “Logo”**

The term “Sponsor Logo” refers to Advertising by a commercial sponsor, who either uses its name and/or its trademark for Advertising in the meaning of the Rules.

The term “Logo” refers to Advertising by a manufacturer/producer of sports equipment, who either uses its name and/or its trademark for Advertising in the meaning of the Rules. Sports equipment means any item in relation to the athlete during a competition, e.g. skiing suit, gloves, ear warmers, goggles or the rifle.

The definitions “Sponsor Logo” and “Logo” refer to the use of Advertising by Athletes as described in detail under section C. and G. and the use of Advertising within the competition facility area as defined in detail under section H. of the Rules.

### **B.2 Own names**

The display of the Athletes’ own names with commercial intent is considered as Advertising.

### **B.3 National identification**

Any items and/or display of national identification such as flags, country names and national/NF symbols/emblems only are not considered as Advertising. They can be used in a rational manner not interfering the overall applicable dressing and/or Advertising concepts.

### **B.4 Host Venue**

Host Venue means the name of the event venue, the administrative and/or tourism region in which the venue is located, and/or the country in which the venue is located, each depicted as a logotype with a pictorial logo, or a graphic depiction. All three terms may be shown at once on print material; however only two of them may be shown concurrently on the start and finish installations, and on any other spaces intended to feature such marketing according to these Rules. For details please see chapter J. Areas for host venue visibility.

### **B.5 Venue related naming rights**

#### **B.5.2 Naming rights of stadiums:**

In the case that the respective stadium of the event is connected with the name of a commercial sponsor such name or the respective part of the name has to be eliminated/covered in the stadium itself and in all event-related external communication. Advertising for the (touristic) regions in connection with the respective Venue is not defined as a commercial sponsor under this rule and shall therefore be permitted within the scope of the Rules, up to prior approval by IBU and its IBU Marketing Partner.

In the case, the naming right of the stadium belongs to an official IBU WC and/or WCH sponsor of the IBU Event, the use of the name can be approved by IBU and the IBU Marketing Partner. Accordant details need to be aligned between IBU and the IBU Marketing Partner well in advance of the respective season.

### **B.5.2 Naming rights of stands:**

In case one or more spectator stands of the respective stadium of the event is connected with the name of a commercial sponsor such name or the respective part of the name has to be eliminated/covered in the respective spectator stands themselves and in all IBU Event-related external communication.

At WC/WCH/YJWCH/OECH/SB WCH Events there shall be the possibility to provide one (1) tribune/grand stand with the specific name of a sponsor (e.g. "BMW-tribune"). However, this opportunity does apply to official WC/WCH/YJWCH/OECH/SB WCH sponsors of the respective Event and season only and is further limited to one (1) tribune/grand stand per Event only. Details need to be aligned between IBU and the IBU Marketing Partner well in advance of the respective season.

### **B.6 Virtual Overlay**

Virtual Overlay is a form of digital transmission where Advertising on defined boards and/or banners in the stadium will be visible only on the specific media device such as TV or tablet.

Upon proposal of the IBU Marketing Partner the IBU may approve such form of Advertising. In any case such form of Advertising has to be timely aligned between IBU and the IBU Contract Partners. Further it has to be considered in depth with regard of any whatsoever legal frameworks and applicable laws/rules and technical requirements."

### **B.7 Audio and/or video**

Audio and/or video Advertising in the Stadium during the live television transmission of the event is prohibited.

### **B.8 Annex 1**

The provisions as stipulated in Annex 1 shall also be considered at any time in connection with the Rules.

## **C. IMPLEMENTATION OF ADVERTISING**

---

Further detailed explanations/interpretations, including explanatory examples and clarifications for the clauses C.1 - C.3 are provided in Annex 1 of these Rules.

### **C.1 Display of Advertising**

Display of any Advertising (in particular any that will appear around action on screen and within the view of the camera) has to be decided by the respective IBU Race Director after consulting the IBU Contract Partners and considering all applicable laws and regulations. Advertising must not intentionally be positioned between the camera and the action on screen. In addition, Advertising must, in principle, be placed in one row only and, except as otherwise permitted in this Annex, must not:

- Move, rotate or change in any way that is visible on screen; however this provision does not apply to technical equipment designed to inform viewers of the progress of the events or of any necessary facilities at the venue.
- Be animated, fluorescent, and reflective or contain laser.

However, illuminated or luminous Advertising is in principle permitted provided IBU approval, to be withheld for good reasons only. If approved, such Advertising needs to have a dimming function.

Advertising on mobile supports such as banners, pennants or inflatables which move shall be prohibited.

## **c.2 Digital/electronic Advertising**

Digital/electronic Advertising (which includes LED boards) may only be used if it adheres to the following principles:

- It may only include limited movement, animation, contrast, muted colours and smooth transitions between different forms of Advertising. Accordingly:
- Each Advertising message must contain one animation at most (any movement of text or graphics will be deemed an animation);
- Special effects (such as glow-effect and flashes) and film-like sequences are prohibited;
- All messages must move in one direction only.
  - Before using digital/electronic Advertising, a technical test shall take place during similar hours and conditions on the day before or if necessary directly before the respective Event.

## **c.3 Items of Advertising**

Advertisements may consist of a maximum of three of the following five items only:

- a company name,
- a trademark,
- either a single noun, or a description of a product or service or a sponsor's primary activity,
- a simple sentence/slogan referring to a product/service/terms of sponsorship (subject to IBU approval)
- a simple non-dominant visual image depicting a product or service,
- a contact URL.

The Rules have to be applied by the parties defined under A.1 of the Rules.

- The IBU and the IBU Marketing Partner will make sure that the specifications for Advertising material designated in these Rules are provided in a timely manner before an event, and that the Advertising areas and Advertising material will be checked immediately before the beginning of an IBU Event.

All Advertising has to be in place 24 hours before the start of the first competition of the respective event week. Following the respective tests (TV/camera) and the checks of the final set-up of any Advertising has to be implemented until 3 hours before the start of the first competition at the latest. Such final set-up shall be agreed in good faith between IBU and all involved partners. Otherwise the respective IBU Race Director will have the final decision which has to comply with the IBU's respective partner contracts and all applicable laws and regulations.



## **D. OFFICIAL EVENT NAME, TITLE SPONSOR**

---

Further detailed explanations/interpretations, including explanatory examples and clarifications for the clauses D.1 - D.3 are provided in Annex 1 of these Rules.

### **D.1 Official Event Name**

The name of the event and the venue are to be written in the Latin alphabet in English, but in addition the LOC/NF can use the country's language/alphabet when needed. In general the names of all IBU Events are to use the following formula: IBU + Event Category (WCH, WC, OECH etc.) Biathlon + Season + Venue. Event names have to be approved by IBU in writing in advance. The Composite Logo of any IBU Event must be approved in advance by IBU.

Names, trademarks, logos and emblems in connections with the name of the Event and/or accordant Composite Logos are solely permitted as approved by IBU, the IBU Contract Partners and sponsors. Any other use of the aforementioned trademarks etc. and any sub-licensing are prohibited without prior written permission of IBU and its Contract Partner. The respective IBU brand guide for detailed description and illustration is applicable.

### **D.2 Title Sponsor**

In case a title sponsor is contracted for IBU series events (WCH, WC, IBU Cup, Junior Cup), the title of the respective IBU Event is to be used in the following format: Title Sponsor + IBU Series Event + Season + Venue

- Example: BMW IBU World Cup Biathlon 2022/23 Pokljuka.

The Event Name with title sponsor has to be approved by IBU in advance.

## **E. WEBSITES**

---

The LOC shall present the Composite Logo and the sponsors on their official websites after IBU approval.

## **F. PRINT MATERIAL**

---

IBU and/or the IBU Marketing Partner will provide a template for the layouts of print materials for all IBU Events. Where applicable IBU Contract Partner logos shall be integrated. As a general rule this layout must be used in all printed materials provided it is technically printable. Any whatsoever deviations need to be aligned and approved between IBU and the IBU Marketing Partner. The IBU brand guide for the respective event is applicable.

IBU and/or IBU Marketing Partner is to approve any print materials used for IBU Events in advance.

## **G. ADVERTISING SURFACES ON TEAM MEMBERS AND SERVICE PERSONNEL**

---

### **G.1 General**

“NF team members” means all team-related staff and competitors participating at the respective events. “Service personnel” means all IBU officials, LOC staff, service providers and service companies on site.

All Advertising on clothing is to be measured in un-stretched condition. The size of any Advertising space (name, written logo, graphic symbol) is the surface area within a line that follows the actual outline of the full trademark. If the trademark is part of a surface that contrasts in colour, the size will be defined as the total area of the contrasting colour. For measuring procedure please refer to IBU Event and Competition Rules Annex A, Art 4. Apart from Advertising surfaces on start numbers (including thigh and training numbers) and apart from any further restrictions arising from these Rules, the responsibility for exploiting Advertising surfaces on Athletes’ clothing lies with the Athletes and their respective NFs.

The defined size of the sponsor may be used to display either one Sponsor Logo or to display multiple smaller Sponsor Logos for the same brand, within the defined advertising space.

### **G.2 Start Numbers (general)**

Please refer to Annex A, Art. 3.2.3 of the IBU Event and Competition Rules for the regulations on the sizes of numbers, also visible in the illustration. As a general rule, the colour of the start numbers must clearly contrast with the base colour of the cloth/fabric (Art. 6.5.1.2 ECR). Exemptions from this general rule may be permitted by the IBU, provided the visibility of the start numbers is not compromised.

In general, the event venue may be shown on all start numbers in all competitions underneath the printed start number figure, with a maximum height of 8 cm. The host venue may also be displayed in two lines as long as the maximum height will not be exceeded. On the right hand strap of the bib on a space with maximum 50 cm<sup>2</sup> the composite logo may be shown. In any case, no change may be made to the design - including the colours - that prevents the clear and unambiguous identification of the start number, especially on TV camera. Any changes including colour changes require the prior written approval of the IBU.

Front (chest) numbers and back numbers must have the same design (mirror image).

The straps or bib's full surface is allowed to be covered with the start number sponsor's chosen colour. However, the full surface may only be covered in a colour if that complete colouring does not interfere with the technical visibility of the start numbers; such colouring must be approved in advance by IBU. Colouring must be clearly different from leader bibs.

### Advertising Principles:

- Unlimited letter height, free choice of upper Advertising space design
- Unlimited letter height, free choice of border Advertising space design
- One Advertising space of 50 cm<sup>2</sup> on the left strap can be placed
- One Advertising space of 50 cm<sup>2</sup> on each side of the bibs in addition to the number on the left and on the right side. The Advertising on both sides shall be identical with the exception of the same Advertising displayed in different languages.

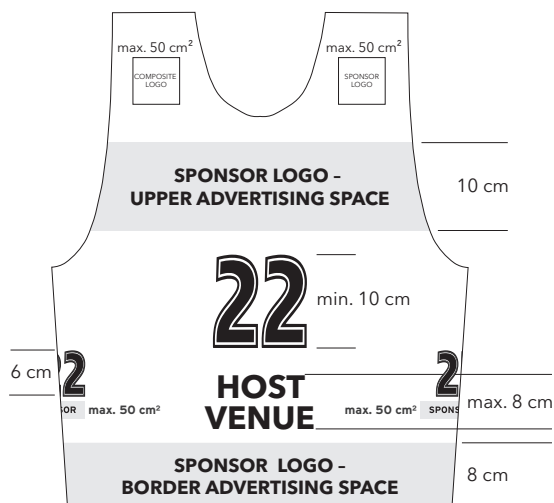

### G.3 Start numbers of Total Score and Cup Score Discipline Leaders

(applies for WC and may apply for IBU Cup, Junior Cup)

Total Score leaders (Yellow start number) &

Cup Score Discipline leaders (Red start numbers) &

Total and Cup Score Discipline leaders (Red/yellow start number):

In all competitions Advertising spaces may be used as specified in G. 2 of these Rules with the following exceptions:

- no Advertising space and no number on the left and on the right side of the bib;
- on the right strap the Events Composite Logo or the IBU Logo can be shown.

#### G.3.1 Start numbers of U25 Leaders

U25 leaders (dark blue): In all competitions Advertising spaces may be used as specified in G.2 of these Rules.

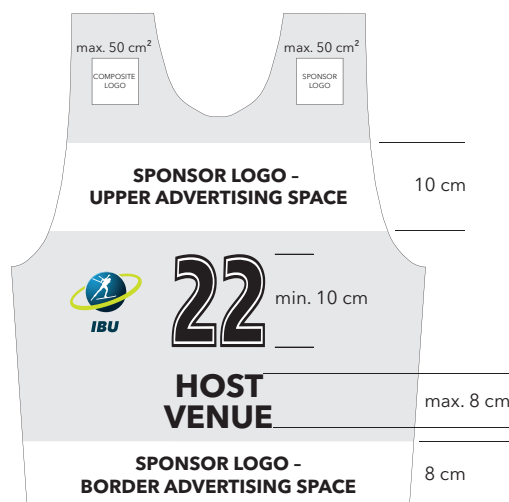

## G.4 Thigh Numbers

In general thigh number stickers must be of the dimensions 15 x 19 cm (with an Advertising space on top of 15 x 6 cm) with a number figure height of 8-12 cm and width of 1-2 cm (please see Annex A, Art. 3.2.3.1 c of the IBU Event and Competition Rules). Exceptions to the size of the sticker can be made if agreed accordingly by IBU and the IBU Marketing Partner. The background may be coloured in a sponsor's chosen colour if there is sufficient contrast between the figure and the background. The numbers should be made from self-adhesive material.

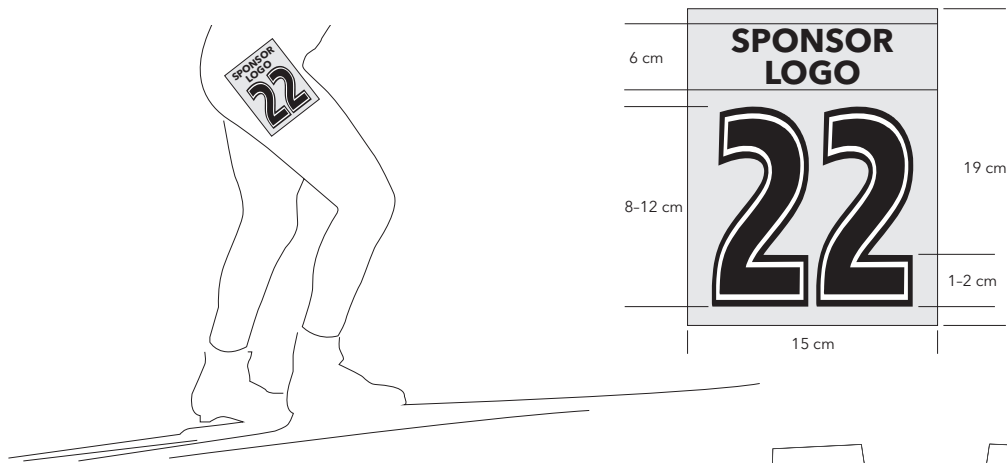

## G.5 Training Numbers for Athletes

The colours and design of the training numbers are set yearly by the IBU in consultation with the IBU Marketing Partner, as per Annex A of the IBU Event and Competition Rules. A sponsor may be presented as shown in the illustration. The maximum height of the Sponsor Logo is equal to the maximum letter height (10 cm).



## G.6 Bibs for service personnel

The colours and design of the bibs for Team Members and photographers are set yearly by the IBU in consultation with the IBU Marketing Partner; the design must clearly specify the occupation of the person wearing the bib. A sponsor may be presented as shown in the illustration. The maximum height of the Sponsor Logo is equal to the maximum letter height (10 cm).

## G.7 Advertising Surfaces on Rifles

A rifle control sticker (RCS) may be placed on both sides of the rifle stocks, each in the size of 12 x 4 cm. The IBU may approve the display of a Sponsor Logo on such sticker (Note: Display has been confirmed until season 2029/2030). It is to be placed on the 15 x 4 cm large, even surface in such a way that it is not covered or cut off in any place. A free space of 1 cm is to be left on all sides of the sticker in which no other Sponsor Logo may be placed, nor any other symbol or sticker. In addition a maximum of three Sponsor Logos per side (pictorial trademark, word-based insignia or logotype) may be shown, and these must be clearly different from the background colour. Their dimensions may not exceed two times 50 cm<sup>2</sup> and one time 25 cm<sup>2</sup>, with free placement. If Sponsor Logos on the "backside" of the stock

will be placed, such Logos can not differ from the ones on the main/front side and can not exceed the before mentioned dimensions. Anyway the placement might differ and the Logos might be smaller. The design and the graphic appearance of the rifle may in no way, shape or form depict or imitate logos of any sponsors, manufacturers or products. Exceptions for left-handed shooters require the prior approval of IBU. The manufacturer's Logo may only be positioned between the front end of the forestock and the front end of the rifle barrel with a maximum size of 6 cm<sup>2</sup>. Any super-structural parts not required for technical reasons to enable proper rifle functioning are not permitted unless they are fully integrated in the rifle stock and have no effect on the rifle handling.

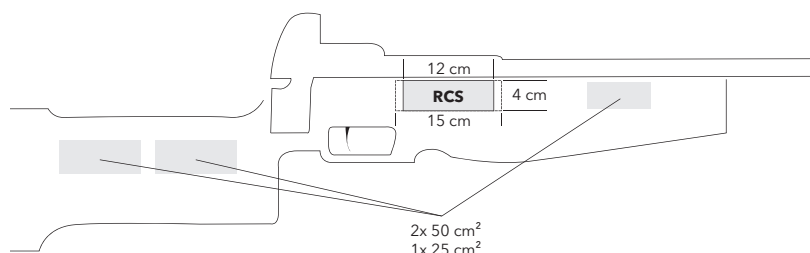

### 6.8 Hats, Headbands, Helmets

Hats, headbands or helmets may feature two Logos on the sides; none of them may be larger than 15 cm<sup>2</sup>, and two identical Logos on the same side are not allowed. The advertisement space in front on hats, headbands or helmets has a total of 50 cm<sup>2</sup> and only one sponsor can be displayed.

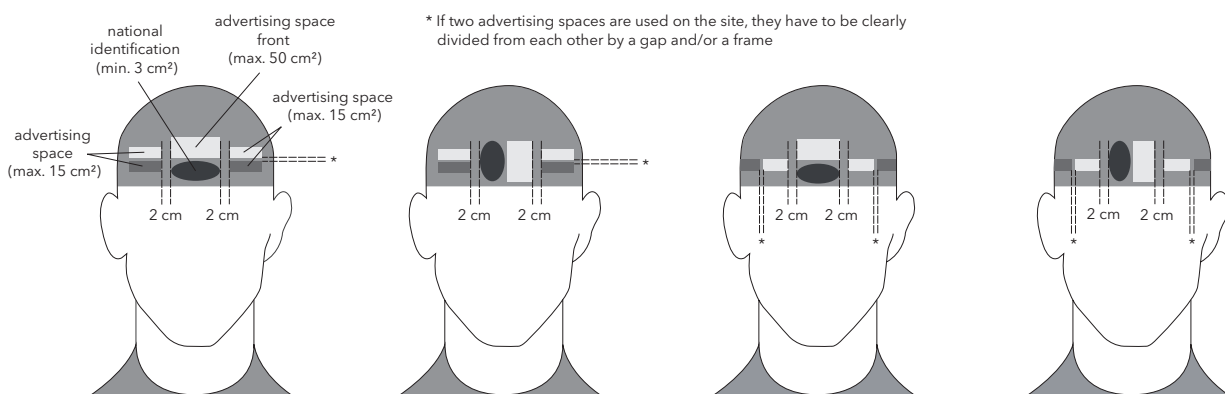

The above drawings apply in principle for all hats / headbands / helmets.

The actual vertical positioning (on headbands, adjacent horizontal positioning) is at the discretion of the NFs. However, the NF team members hat, headband or helmet must show the national identification of the federation, national flag or name of the country of the federation concerned on the front (forehead) side as shown in the drawings above and whenever there is any advertising displayed. Mandatory display of national identification does not apply for other groups than NF Team members. The minimum distance between the Advertising spaces and the national team emblem/national flag/name of country must be at least 5 cm, measured from the centre of the emblem. The latter must have a size of at least 3 cm<sup>2</sup>. If Athletes wear a helmet, hat or headband in combination, the Advertising may be placed only on one - either: hat, headband or helmet.



### 6.9 Goggles, Goggle Frames and Goggle Straps

The dimensions of goggles, goggle frames and goggles straps must be equivalent to those of commercially available items. However, both, the goggle straps as well as the manufacturer's Logo on the strap may be no wider than 4 cm. Goggles, goggle glass and goggle straps may only show the logo of the manufacturer as on the commercially available item. If double straps are used, the commercial trademark may be shown on one strap only.

### 6.10 Ear Warmers

Only one sponsor or Logo may be shown per ear of max. 15 cm<sup>2</sup> in size.

### 6.11 Gloves

Advertising space of max. 15 cm<sup>2</sup> in total for sponsors and/or Logos may be featured on each glove (left and right). Left and right glove have to look identical in terms of Advertising. The area may be divided into two spaces for two sponsors/Logos.

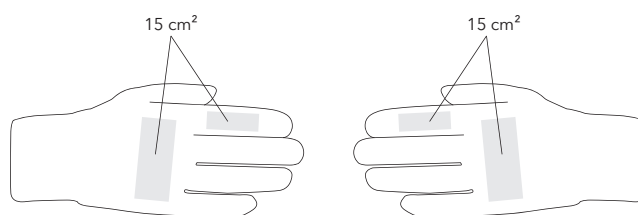

### 6.12 Skiing Suit, Thermal Suits and Outer Clothing

The total area of all sponsors and Logos on skiing suits, thermal suits and outer clothing may not exceed 450 cm<sup>2</sup>. Any Advertising on skin is prohibited.

The total area of any individual Sponsor Logo or Logo may not exceed 100 cm<sup>2</sup>. Identical Sponsor Logos or Logos may not be placed one above the other, nor besides each other. If additional items of clothing (such as gaiters) are worn on top of a skiing suit, thermal suit and/or outer clothing, they may not feature any type of logo.

The design of skiing suits, thermal suits and outer clothing and any additional items of clothing must not display or imitate Sponsor Logos, Logos, symbols or products in any manner or form. Sponsor Logos and/or Logos are permitted in the following positions: on the skiing suit, the thermal suit and the outer clothing on the outer seam of each sleeve (from the collar to the cuff) and on the outer seam of the upper body clothing and of both legs (starting at both armpits to the lower end of the trouser leg seam). In cases where a skiing suit, thermal suit or outer clothing consists of two individual parts (top and trousers), the foregoing will apply accordingly.

### 6.13 Neck Warmers

Neck warmers may only show one Sponsor Logo or Logo with a maximum size of 15 cm<sup>2</sup>. If more than one neck warmer is worn, Advertising may be placed only on one.

### 6.14 Skis, Bindings, Poles and Other Hardware Products

Only Logos of the actual manufacturer are permitted.

### G.15 Straps of Rifle Carrying Harnesses

One Sponsor Logo or Logo of max. 6 cm<sup>2</sup> underneath the fixation of carrying harness system is permitted. A Sponsor Logo or Logo of max. 30 cm<sup>2</sup> may be attached on each strap of the rifle carrying harness. This space may also be divided into spaces for two Sponsor Logos or Logos. The outer and inner side of the carrying harness may differ from each other in appearance; however the left and the right strap must be identical.

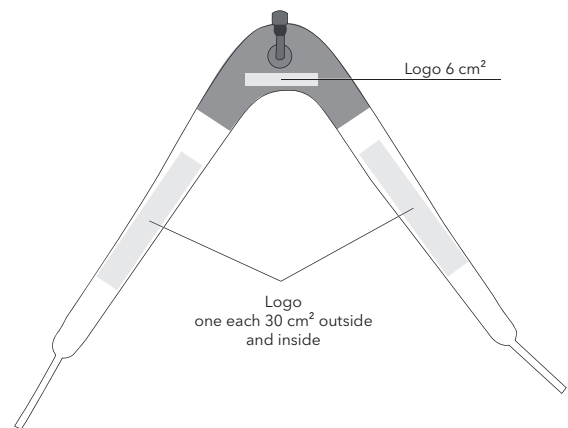

### G.16 Shooting Straps and Arm Loops

On the shooting strap and arm loop, one Sponsor Logo or Logo is permitted with the dimension of 30 cm<sup>2</sup>.

### G.17 Water Bottle Waist Belts

Water bottle waist belts may show a total Advertising space of 100 cm<sup>2</sup>. This space can be divided in multiple spaces for Sponsor Logos or Logos of the same sponsor/manufacturer.

### G.18 Rifle Case/Rifle Bag

Rifle cases and rifle bags may only show an Advertising space with maximum total dimensions of 50 x 15 cm (750 cm<sup>2</sup>). This space may be divided into a maximum of two separate spaces for Sponsor Logos or Logos of the same sponsor/manufacturer.

### G.19 Ski clips

Two ski clips may be displayed on the skis, one above the binding and one below. Advertising space may not exceed 50 cm<sup>2</sup> on each side, such that only one side is visible from any perspective. All the Sponsor Logos or Logos on the two ski clips must be identical. They should be placed so as not to obscure the Logo/wordmark of the ski manufacturer. The clips must be in function.

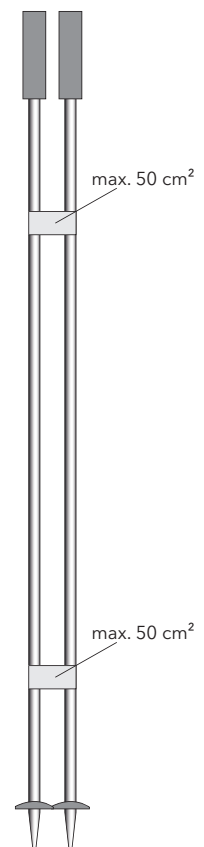

### G.20 Pole Clips

A maximum of two pole clips are permitted. The total surface area of one clip side may not exceed 50 cm<sup>2</sup>, all the Sponsor Logos or Logos on the two pole clips must be identical. The clips must be in function.

### G.21 Telescopes and Stands

Sponsor Logos or Logos are permitted on telescopes on no more than two surfaces per side, each with a maximum area of 50 cm<sup>2</sup>.

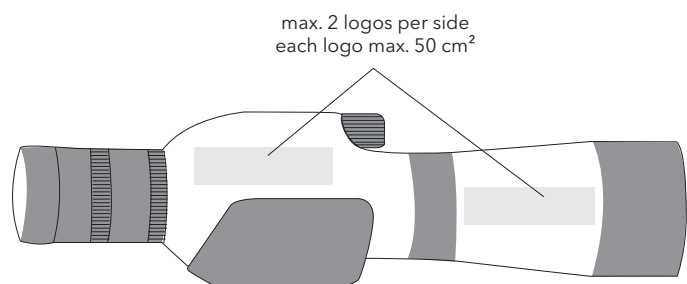

The Logo of the manufacturer is permitted on the stand and stand carrying strap with the dimension of 15 cm<sup>2</sup> per leg (max. 3 legs) and of 30 cm<sup>2</sup> on the carrying strap.

## **G.22 Magnetic boards / tables / tablets**

Magnetic boards/tables or tables, used to display the shot location may show one Sponsor Logo or Logo with a maximum area of 50 cm<sup>2</sup>.

## **G.23 Umbrellas**

Umbrellas may show a total Advertising space of 100 cm<sup>2</sup>. This space can be divided in multiple Sponsor Logos or Logos of the same sponsor/manufacturer.

## **G.24 Ceremonies**

### **G.24.1 Flower Ceremony**

Athletes may appear at Flower Ceremonies only with their competition equipment (start number, skiing suit, hats, hatbands, goggles, ear warmers, gloves, neck warmers, skis and bindings, rifle, armloop). Thermal suits and other outer clothing and ski and pole clips are permitted in line with the rules above.

### **G.24.2 Medal Ceremony**

Athletes may appear at Medal Ceremonies only with the following competition equipment: Skiing suit, hats, hatbands, gloves, goggles, neck warmers. In alternative the Athlete may wear any other thermal suits or outer clothing in line with the rules above.

## H. COMPETITION FACILITY AREA

### H.1 Principle Specifications concerning Advertising Media and Presence of TV Camera

The definitions "Sponsor Logo" or "Logo" (defined under clause B.1 of the Rules) refer to Advertising space exploitable as defined in these Rules.

The defined size of the sponsor may be used to display either one Sponsor Logo or to display multiple smaller Sponsor Logos for the same brand, within the defined Advertising space.

The competition facility includes the stadium (with grandstands etc.), the entire skiing and shooting area, and all other competition-related ground surfaces, buildings, constructions and installations for hosting the respective event. The competition facilities at the various event venues are not all alike. For this reason it is not possible to state exact positioning specifications for Advertising media. The following fundamental specifications are to be applied accordingly to the respective competition facilities. On account of differing national media legislation and varying contractual circumstances, the details of how to position the Advertising media and the TV cameras must be coordinated with the respective OC and with the IBU Contract Partners. The final decision is taken by the IBU. On boards, flags and other Advertising media, the Advertising spaces must not be higher than 120 cm if not stipulated to the contrary within these Rules; however, there is no restriction on the height of the letters.

### H.2 Advertisement on Competition Venue Areas Relevant to TV

#### H.2.1 Stadium / Penalty loop

Banners in stadium/at penalty loop:

- Height max. 120 cm;
- Unrestricted letter height, free banner design;
- Length and quantity of banners is unrestricted and variable;
- Breakers may be used as a vertical borderline (max. width 30 cm).



## H.2.2 Shooting Range

### a. Banners on shooting range left and right side wall:

- Height max. 120 cm;
- Unrestricted letter height, free banner design;
- Length and quantity of banners is unrestricted and variable;
- Breakers may be used as vertical borderline (max. width 30 cm.)

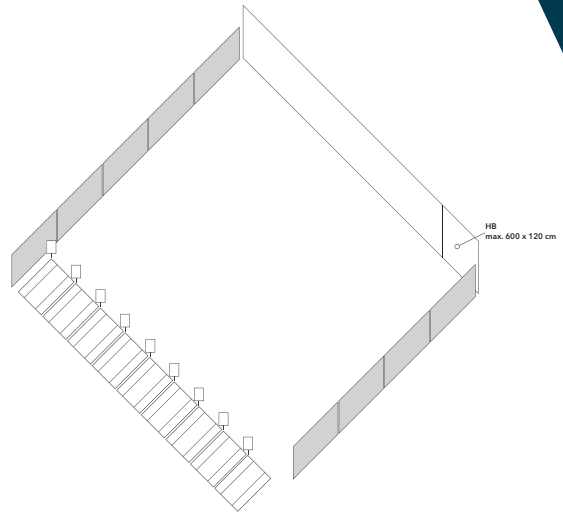

### b. Banners as borderline towards shooting range personnel:

- Sixteen (16) banners in the accustomed format 400 x 80 cm will be placed in the first section of the shooting range, with an area of one (1) meter width left empty for the shooting range staff (passageway/empty area) after every two banners.
- 35m along the first section there is a gap reserved for the rifle stands. Further passageway areas (2 m each) should be provided to the left and right of the rifle rack area.

Principles:

- Unrestricted letter height, free banner design;
- Position and arrangement in front of the shooting range staff, without obstruction of line-of-sight;
- Unhampered access to ramp.

### c. Advertising above the targets/target roof:

Advertising is allowed on a total length of 90 m, with the Advertising space being 1.20 m high and letters not higher than 1 m. It is a further condition that the site conditions, camera positions and concrete geographical conditions of the shooting range permit such Advertising measures. The name of the venue/region may be featured in the same size in coordination with approval from the IBU/the IBU Marketing Partner. The logo/wordmark of the IBU TV Partner or the respective HB may be shown above lane 1 and 2 on a banner (max. dimension 600 x 120 cm). Any deviations need prior approval from the IBU in consultation with its IBU Contract Partners.

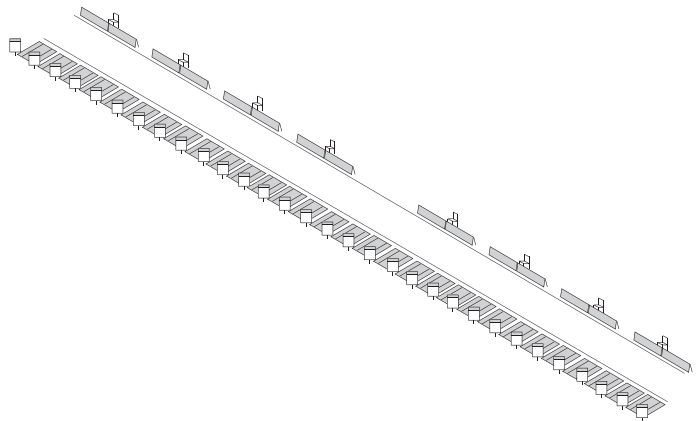



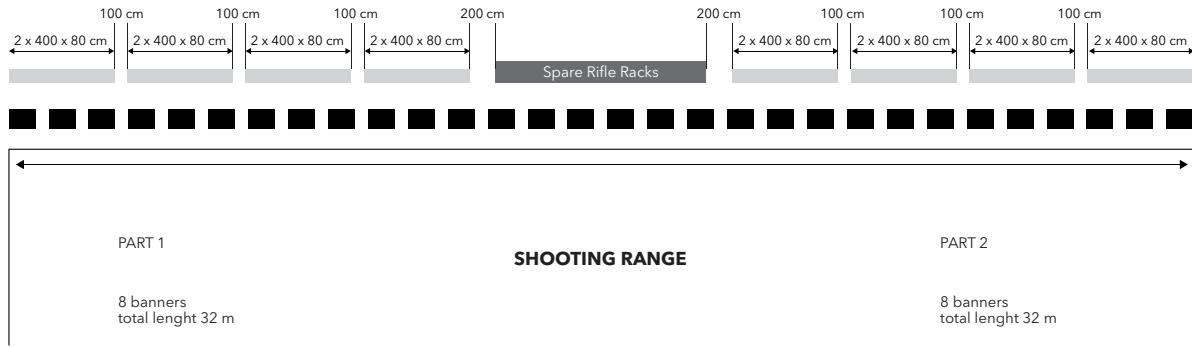

**d. Shooting Mats:**

Advertising space on left and right side, each max. 40 cm x 150 cm, the sponsor on both sides has to be the same as well as the base colour throughout the whole mat (message may vary on each side/mat).

Base colour is generally permitted to vary, but must not change during the competition week.

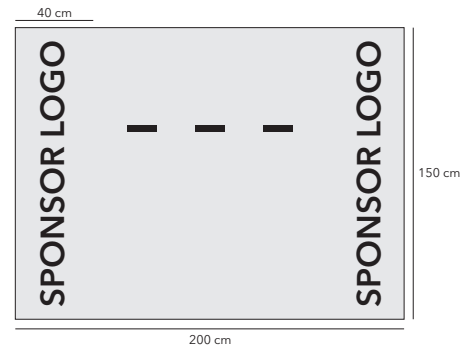

**H.2.3 Course**

**a. Banners on course (except single positions):**

Banners on course may have a height of max. 120 cm. Unrestricted letter height, free banner design. The maximum length per curve/banner sequence may be up to 36 m. Multiple sequences may be permitted. Any exception to this principle may be granted by the IBU due to individual circumstances. Breakers may be used as a vertical borderline (width max. 30 cm).



**b. Banners on Single Position:**

- Height max. 150 cm;
- Variable length of banner(s) at individual positions;
- Unrestricted letter height, free choice of banner design.

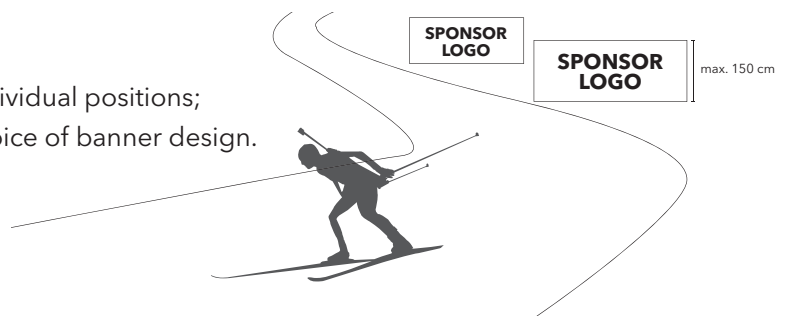

## H.2.4 Installations in Stadium / on Course

Regarding the form and dimensions of start and finish installations, please see the illustration. The shape and design is subject to change and needs to be approved by IBU. Sponsors may be featured on such installations. All illustrations mentioned below are examples only – red marked measurements are mandatory.

### a. Installations for Individual Start (host venue has to be displayed)

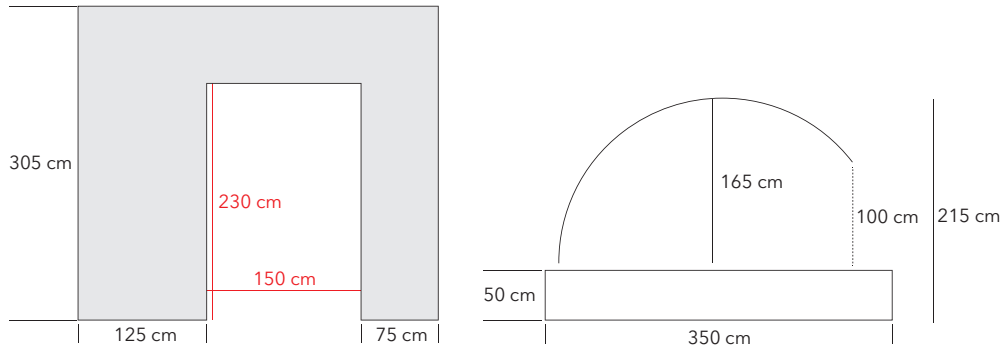

### b. Installations for Mass Start, Pursuit Start, Relay Start and Finish (host venue has to be displayed)

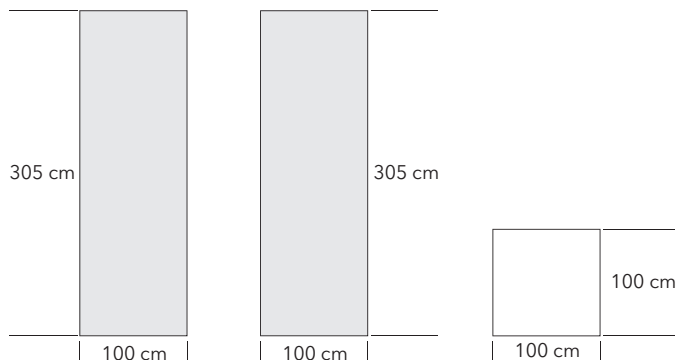

### c. Split-Time Installations

The exact positions will be decided in agreement with the IBU Contract Partners. The form and the overall design may be changed with the approval of IBU.

### d. Stadium Split-Time

Logo/wordmark of IBU TV Partner or HB maybe shown on a board with the dimensions of 50 cm x 80 cm next to the installation. Any deviations need prior approval from the IBU in consultation with its IBU Contract Partners.

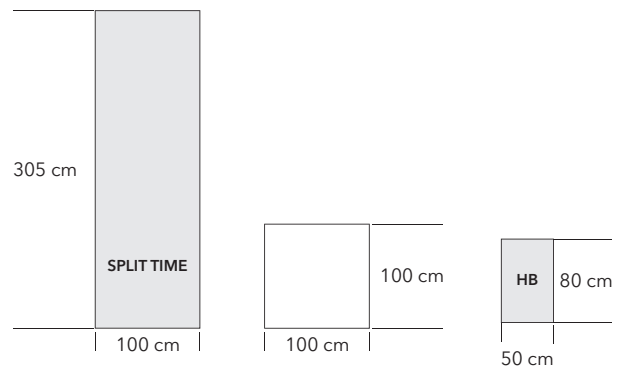

### H.2.5 V-Boards

V-Boards may in principle not exceed a height of 20 cm and a total length of 100 cm, Advertising can be placed on the complete surface, free design.



### H.2.6 Shooting Lane Numbers

According the size please refer to Art 3.4.5 of the IBU Event and Competition Rules.

The LOC is to ensure that on top of the lane numbers a reserved space for Advertising with a height of 10 cm is provided. The backside must display the same information as the front side in case of TV/live stream productions.

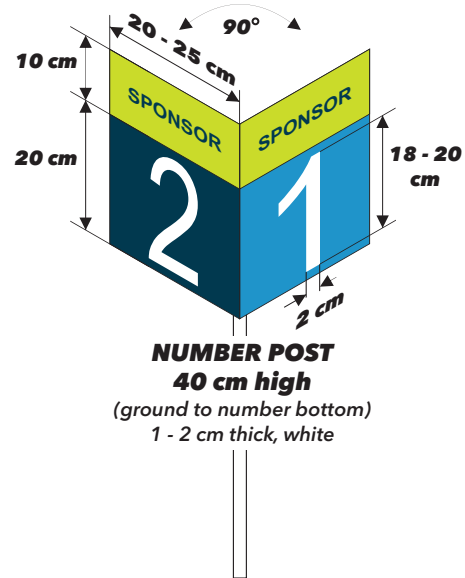

### H.2.7 Advertising below Targets

For sizes and surfaces, please see the illustration.

The colour of the Advertising space needs to be approved by IBU beforehand.

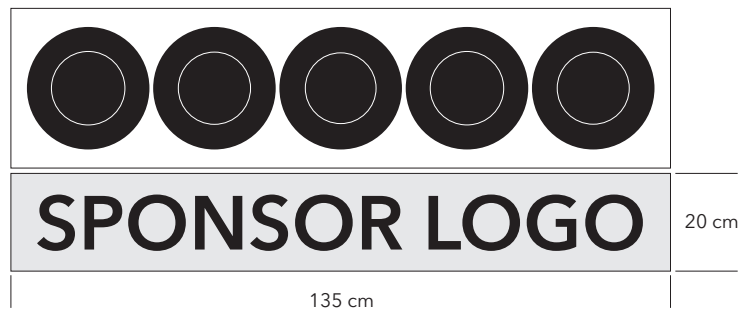

### H.2.8 Victory Podium

The podium is to be provided by the LOC. The design must be approved by the IBU/the IBU Marketing Partner prior to the event. On the victory podium, the name of the venue may be displayed on a surface of 25 cm height and 80 cm width with a letter height of 20 cm, below the IBU Logo. Alternatively the Composite Logo can be placed as well as it features event venue and IBU Logo.

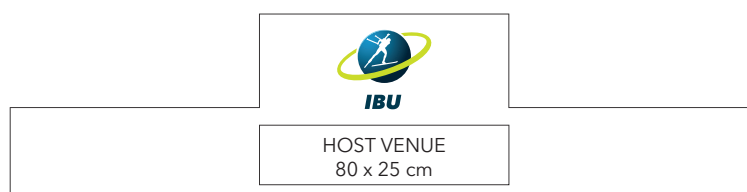

### H.2.9 Video screens

Max. two Logos may be displayed underneath the screen. The height of the Advertising space may not exceed 120 cm; unrestricted letter height, free space design. For information on dimensions, location and surfaces, please see the illustration.

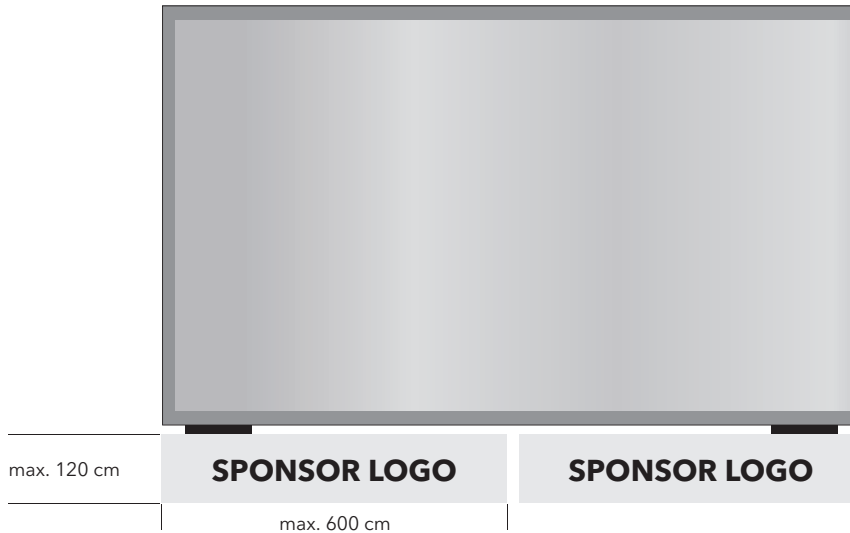

### H.3 Special Multi-Area Advertising Media

Special Advertising medias are Advertising media that can be placed within the stadium area, shooting range area or on the course in addition to Advertising banners and/or other existing items of Advertising defined in these Rules and/or novel, approved items of Advertising. Existing special Advertising media that have been used by the IBU Marketing Partner in the past include, for instance, inflatables and car placement. "Novel special Advertising media" refers to Advertising media described in these Rules and/or to any other new (and/or previously unknown) Advertising media that may be used in the future, after prior approval by the IBU. The following special Advertising media are permitted:

- a. Six (6) special Advertising media (3D, inflatable or similar) where of max. two (2) are to be placed in the stadium area and max. four (4) on the course;
- b. One (1) car placement, as specified in the car sponsor's contractual benefits (in addition to a. and c.);
- c. One (1) snow-based Advertising spot, subject to IBU's prior approval, which the IBU must not unreasonably withhold (in addition to a. and b.).

#### H.3.1 3D Implementations / Inflatables or similar installations

- a. Max. dimensions of **3D implementations** (including possible background construction): 500 x 400 x 200 (width x height x depth).

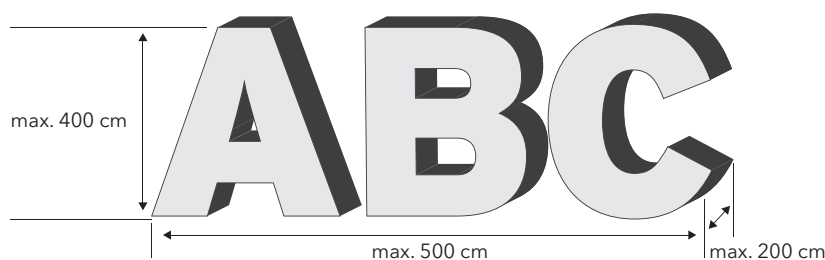

**b. Max. dimensions of Inflatables/similar installations:**

500 x 400 x 400 (width x height x depth).

The full surface can be used for Advertising, i.e. unrestricted letter height, free design - to approved by IBU in advance.

However arch solutions (e.g. inflated archs over any course part) are not allowed.

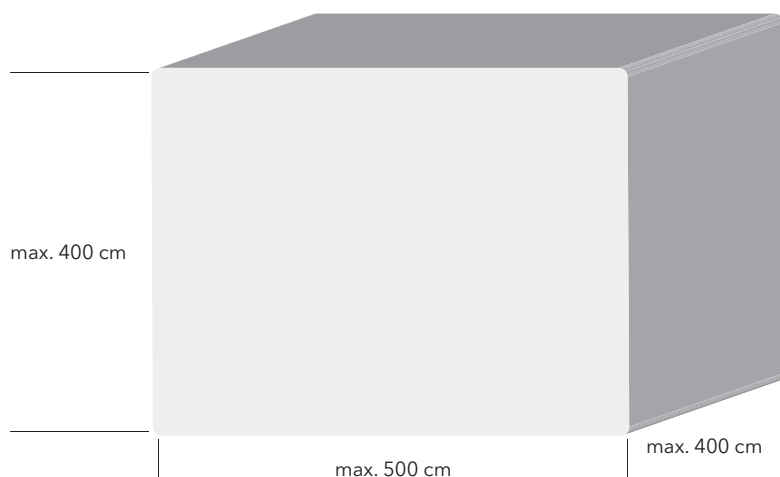

### H.3.2 Car placement

- Placement requires the prior approval of the IBU;
- Car placement is integrated in the particular package of the car sponsor and can be placed in the vicinity of the shooting range, the stadium or on the course (in TV relevant area);
- Maximum dimensions of the vehicle presentation platform: 600 x 400 x 120 cm;
- Maximum height of the back wall 300 cm (from platform base);
- Sponsor is free to choose the car displayed (type, colour, configuration, which may not exceed the original size of the respective car);
- Inside and outside illumination of the car is permitted;
- Car placement may also be a two-dimensional display (for example a poster or illuminated poster);
- The full surface of the backwall/podium/car can be used for Advertising, i.e. unrestricted letter height, free design - to be approved by IBU/the IBU TV Partner in advance of the event.

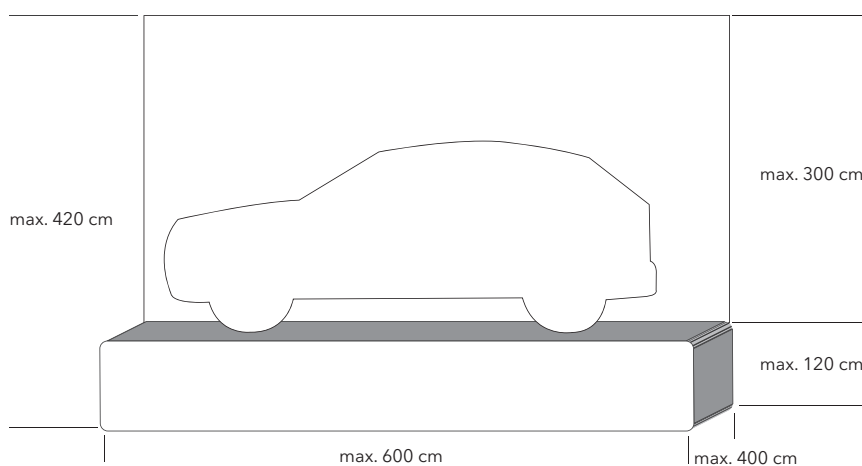

All illuminated parts must have a dimming function.



### H.3.3 Advertising in Snow

Advertising in snow has to be coordinated in advance and agreed on with IBU, after consulting the IBU Contract Partners and observing the national laws. The maximum dimension is 50 m<sup>2</sup>.

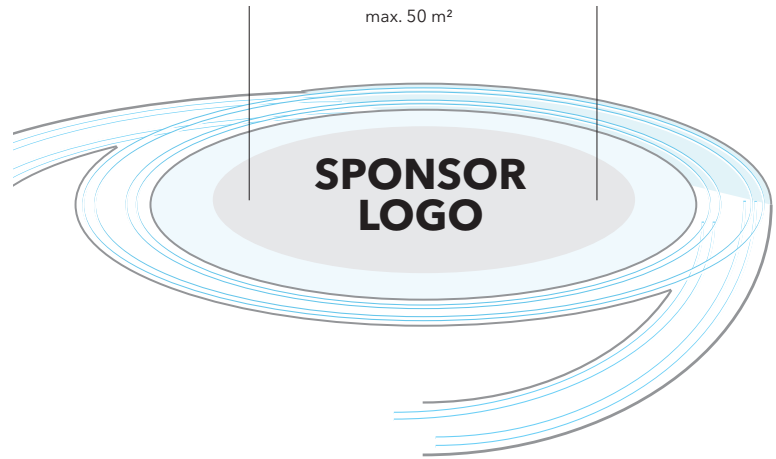

## **I. OTHER ADVERTISING PANELS**

### **I.1 Flower Ceremony and Award Ceremony Back Wall**

- Width max. 450 cm;
- Height max. 350 cm;
- Sponsors can be displayed;
- Event Logo on top left and title sponsor on top right side (if not in use, Event logo to be used twice)
- Host venue surface height: max. 21 cm.

There shall be the possibility for an appropriate integration of two (2) sponsors and the Host Venue in course of the award/prize ceremony (e.g. depiction of title sponsor and BIB sponsor on LED boards at the award/prize ceremony). Details need to be aligned between IBU and the IBU Contract Partners.

### **I.2 Press Conference Back Wall**

- Width 400-600 cm;
- Height max. 225 cm;
- Event logo on top left and title sponsor on top right side (if not in use, event logo to be used twice);
- Host venue surface height: max. 21 cm.

### **I.3 Accreditation Pass Straps**

Advertising is permitted on IBU accreditation pass straps in the graphic design pattern shown below; unrestricted letter height, free design upon approval of IBU.

<b>SPONSOR LOGO</b>	<b>IBU EVENT/SERIES</b>	<b>SPONSOR LOGO</b>	<b>IBU EVENT/SERIES</b>	<b>2 cm</b>
-------------------------	-------------------------	-------------------------	-------------------------	-------------

### **I.4 Media Compound Interview Wall**

The wall will be provided by the IBU Marketing Partner/LOC, if deemed necessary. All TV companies conducting interviews in the mixed zone shall use the mixed zone interview wall if set-up. The width of the mixed zone interview wall depends on the area of the mixed zone used for TV broadcasting, and will be decided by the responsible on-site IBU staff after consulting the IBU Contract Partners. Certain separate spaces on the interview wall are available to each respective broadcaster (rightsholder).

### **I.5 Leaders Lounge**

IBU and the IBU TV Partner might agree on the need for a so called leaders lounge for selected events, e.g. IBU WCH. Such lounge/room shall be located as close as possible to the finish exit area. The display of sponsors can be granted by IBU; anyway exact design/dimensions are up to the pre-approval of IBU and the IBU TV Partner.

## **J. AREAS FOR HOST VENUE VISIBILITY**

---

The name of the Host Venue may be featured on the following areas as described in detail on the corresponding sections. The wordmark and/or logo of (touristic) regions in connection with the respective Venue may be also displayed.

**G.2** Start Numbers (general)

**G.3** Start numbers of Total Score and Cup Score Discipline Leaders

**G.12** OC Officials Clothing (venue/region name/logo - subject of IBU approval)

**H.2.4** Installations in Stadium (start & finish)

**H.2.8** Victory Podium

**I.1** Flower Ceremony and Award Ceremony Back Wall

**I.2** Press Conference Back Wall

## **K. AREAS OF ACTIVITY OUTSIDE THE COMPETITION FACILITY**

---

The areas of activity outside the competition facility refer to those areas that are not part of the competition facility but that host activities of an official character that are related to the IBU Event within the period of one day before the teams' arrival until and including the last competition day (e.g. official opening ceremony, victory ceremony, hand-out of start numbers etc.).

### **K.1 Logistics offices**

At least one board, with the dimensions 2 x 2.5 m, may be provided showing all event sponsors, IBU Contract Partners and IBU supplying partners and shall be positioned by the IBU at a top-priority site. At least one board, with the dimensions 2 x 2 m, must be provided for the NF as arranged and laid out by that federation, and positioned at a medium-priority site.

### **K.2 Team Captains Meetings/Press and Sponsor Receptions**

At least one board may be provided, with the dimensions 2 x 2.5 m, showing all event sponsors, the IBU Contract Partners and the IBU supplying partners and positioned by the IBU at a top-priority site. At least one board must be provided, with the dimensions 2 x 2 m, for the NF as arranged and laid out by that federation, at a medium-priority site.

### **K.3 Award Ceremony, Start Number Hand-out and Similar Public Appearances**

Advertising wall (in the central stage area) - to be approved by IBU/the IBU Marketing Partner.

In principle the same layout as for flower ceremony and press conference wall shall be used. Exceptions for ceremonies without the inclusion of any sponsors have to be approved by the IBU/the IBU Marketing Partner beforehand.

There shall be the possibility for an appropriate integration of two (2) sponsors and the Host Venue in course of the award/prize ceremony (e.g. depiction of title sponsor and BIB sponsor on LED boards at the award/prize ceremony). Details need to be aligned between IBU and the IBU Contract Partners.

#### **K.4 VIP Tent**

One board must be provided with the dimensions 2 x 2.5 m displaying all of the official event sponsors, IBU Contract Partners where applicable and IBU supplying partners and as positioned by the IBU in a top priority site at the entrance. One board with the dimensions 2 x 2 m must be provided for the NF as arranged and laid out by that federation, and positioned at a medium-priority site.

#### **K.5 Other Areas of the Facility**

At least one board must be provided with the dimensions 2 x 2.5 m showing all official event sponsors, the IBU Contract Partners and the IBU supplying partners and positioned by IBU in a top priority site, preferably at the most central entrance area within the field of view of the flow of spectators. At least one board with the dimensions 2 x 2 m must be provided for the NF as arranged and proposed by that federation, positioned at a medium-priority site.

#### **K.6 Reporting Results**

The IBU reserves the right to report the results of the respective event itself in any existing and/or future electronic media whatsoever, and the right to license programs of any kind.

### **L. TV SCREEN RELATED ADVERTISING**

---

There may be no dedicated visual or audio effects and/or references to an online domain or address included in this identification. On-screen identifications will be authorised only for companies whose principal activities include the provision of the equipment used (hardware) and/or the service (software) ("the Company(ies)"). New forms of data processing such as Hawk-Eye and 3D animations shall be subject to the prior written approval by the IBU after consulting the IBU TV Partner.

Injection/display requirements:

- a) The identification of the Company providing the timing service shall appear on-screen only at the same moment as information regarding a competitor's time at the finish and/or any other usually accepted moment (e.g. intermediate time/end of shooting session) appears. The identification of the Company providing computing and results service shall appear on-screen only with the display of the data provided by such Company.
- b) The identification of the timing or data processing Company/Companies on the television screen (signal injection) shall be as follows:  
Timing: maximum of 4 seconds per identification;  
Data: maximum of 6 seconds per identification.

#### **L.1 Size and position of identifications:**

- a) The height of the letters of the identification of the Companies must not exceed the maximum height of the simultaneous broadcast display of data. The display of any Company's trademark protected logo shall be subject to prior written approval by the IBU TV Partner.

Identification of the Company's logo on-screen shall be via a static graphic. Notwithstanding this, it shall be permitted for such Company's logo to appear and disappear on screen by zooming "in" and

"out". No other movement of the logo, in particular any movement across the screen, shall be permitted.

b) The maximum height of television lines for the identification of any Company shall be fixed at 23 pixels for productions in SD (1024 x 576 pixels) and at 44 pixels for productions in HD (1920 x 1080 pixels). The Company's identification shall appear either at the bottom in the centre of the screen and below that of the data display or alternatively in a central position to the right hand side of the data display. The Company's identification may also appear adjacent on top of the data display in a central position if the general layout of the data display reasonably requires this and if this has been agreed by the IBU.

## **L.2 Wording of identifications**

The Company shall be identified either by its usual trading name which may be in the font of a trademark protected word and, if requested by the Company, the use of either of the following additional words:

- a) for timing Companies: "timing", "watches" or similar;
- b) for data processing Companies: "computer", "data", "data software", "data networks", "data applications", "business software" or similar.

## **M. LIMIT OF PROVISIONS/ACKNOWLEDGEMENT OF CURRENT PRACTICE**

---

In case any sponsor/third party intends to implement Advertising/visual identification in a form/shape that is not expressly stated in these Rules it has to seek for and obtain IBU's (or where applicable the IBU Contract Partners') prior written approval before such identification shall be considered accepted. Such approval shall not be unreasonably withheld.



## **ANNEX 1 OF THE IBU ADVERTISING RULES 2022-2026**

**(APPROVED AT EB 162, 19-20 JUNE 2022 )**

Following a common understanding of IBU and the IBU Contract Partners the meaning/interpretation of the following paragraphs of the IBU Advertising Rules 2022-2026 (effective as after EB approval; hereinafter "Rules") shall be agreed, clarified and/or specified as follows:

### **ad C.1**

The IBU and the IBU Contract Partners agree on the following specification/interpretation of section C.1 of the Rules and therefore the wording of C.1 shall be interpreted, specified and understood as follows:

*"The placement of any Advertising (in particular any that will appear around action on screen and within view of camera) is to be decided by the respective IBU Race Director after consulting the IBU Contract Partners and considering all applicable laws and regulations. Advertising must not intentionally be positioned between the camera and the action on screen. In addition, Advertising must, in principle, be placed in one row only (geographically identical positions are not allowed- see exemplary images below) and, except as otherwise permitted in these Rules (including its Annexes), must not:*

- Move, rotate or change in any way that is visible on screen, however this provision does not apply to technical equipment designed to inform viewers of the progress of the events or of any necessary facilities at the venue;
- Be animated, fluorescent and reflective or contain laser:

(i) Allowed: (geographically different position)

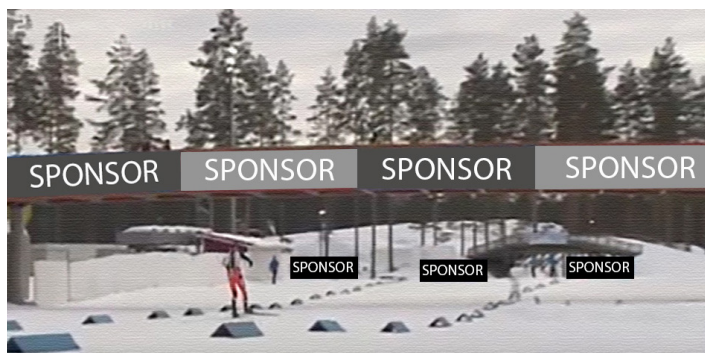

(ii) Not allowed: (geographically identical position)

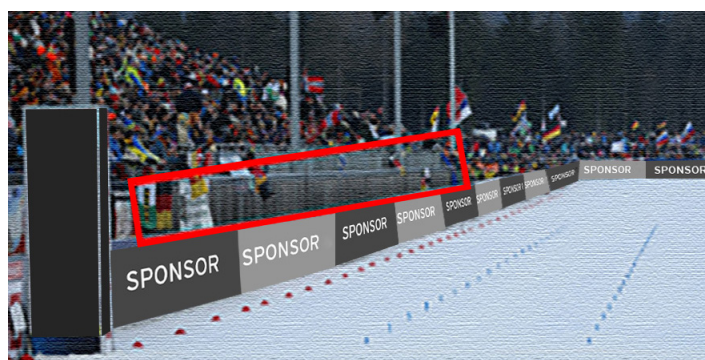

*However illuminated or luminous Advertising is in principle permitted provided IBU approval, to be withheld for good reasons only. If approved, such Advertising needs to have a dimming function. Advertising on mobile supports such as banner, pennants or inflatables which move shall be prohibited."*

## **ad C.2**

The IBU and the IBU Contract Partners agree on the following specification/interpretation of section C.2 of the Rules and therefore the wording of C.2 shall be interpreted, specified and understood as follows:

*Digital/electronic Advertising (which includes LED boards) may only be used if adheres to the following principles\*:*

- *It may only include limited movement, animation, contrast, muted colours and smooth transitions between different forms of Advertising;*
- *Each banner sequence/Advertising message (according to C.3 of the Rules) must contain no more than one animation at the same time (simultaneously). Any movement of text or graphics will be deemed an animation, whereas a banner sequence/Advertising message containing text and/or graphic elements and moving continuously from left to right or vice versa shall be deemed one animation only (e.g. ten (10) identical cars moving from the left to the right on one banner sequence = one (1) animation). Multiple animations in succession (not at the same time) are allowed, provided that a smooth transition of animations is ensured and not more than six (6) animations will appear within a period of 30 seconds;*
- *Special effects (such as glow-effect and flashes) and film like sequences are prohibited;*
- *All messages (e.g. graphics/symbol, text, trademark etc.) must move in one direction at the same time only; and*
- *Before using digital/electronic Advertising, a technical test shall take place on the day before or, if necessary, directly before the respective Event during hours and conditions similar to the ones during the relevant Event.*

*\* Exceptions/deviations of the aforementioned principles require approval by the IBU and the IBU TV Partner.*

### ad C.3

The IBU and the IBU Contract Partners agree on the following specification/interpretation of section C.3 of the Rules and therefore the wording of C.3 shall be interpreted, specified and understood as follows:

“Advertisements may consist of a maximum of three of the following five items only:

- a company name;
- a trademark;
- either a single noun, or a description of product or service or a sponsor’s primary activity;
- a simple sentence/slogan referring to a product/service/terms of sponsorship and/or sponsorship activation/campaign (subject to IBU approval);

Examples:

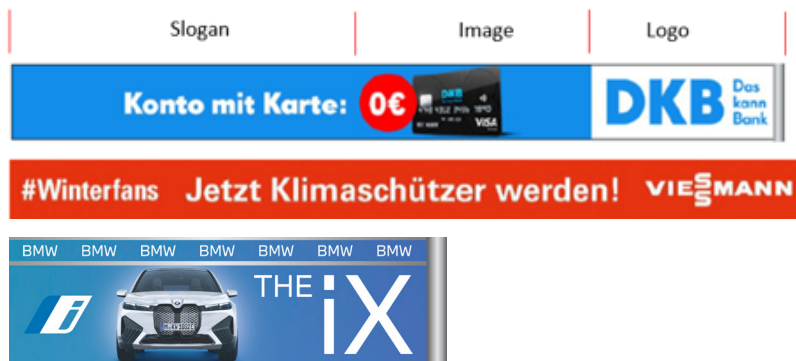

- a simple non-dominant visual image depicting a product/service

Examples:

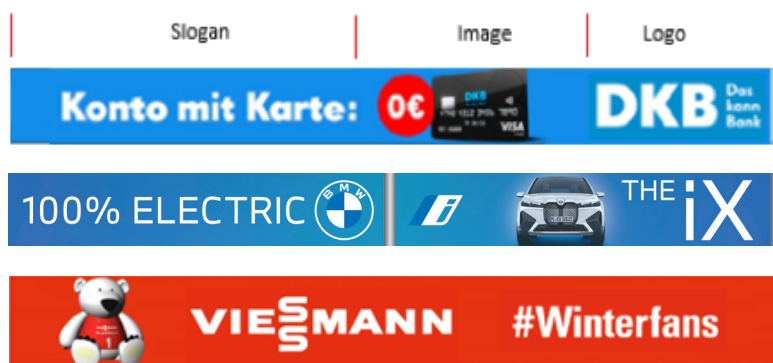

- a contact URL and/or Hashtag (#)

Examples:





OR



**ad D.1/D.2/D.3**

The IBU and the IBU Contract Partners agree on the following implementation of rights listed in section D.1 & D.2 & D.3:

Examples	On screen (TV graphics)
<p><b>WC</b></p>	
<p><b>WCH</b></p>	



INTERNATIONAL  
**BIATHLON**  
UNION

**[www.biathlonworld.com](http://www.biathlonworld.com)**

Sonystrasse 20, 5081 Anif b. Salzburg, Austria  
Telephone +43 - 662 - 85 50 50